



## THREE PHASE ASYNCHRONOUS ELECTRIC MOTORS

### OPERATING MANUAL

(Original Instructions)

**MES Elektromekanik Dokum San. ve  
Tic. A.S.**

G.O. Paşa Mah. 1.Cad No : 125  
2. Org. San. Bolgesi 59500 Cerkezkoy / Tekirdag / Turkey  
Tel : +90 282 726 92 94  
Fax : +90 282 726 90 42  
Mailto : [info@mesdokum.com.tr](mailto:info@mesdokum.com.tr)

## 1. INTRODUCTION /GENERAL DESCRIPTION

These instructions describe the electric motor and explain best practices in motor handling, from initial delivery to final disposal of the equipment.

These instructions must be followed to ensure safe and proper installation, operation, and maintenance of the motor.

### Area of application and Intended use of the motors

ELK motor is an electric motor that converts electric energy into mechanical energy. Our product family defined in this manual is a three phase squirrel cage induction motor

Motors of this series are self-ventilated low voltage three phase asynchronous motors with a cylindrical shaft end and feather key way

The threephase electric motors of this series are used as industrial drives. They are designed for a wide range of drive applications both for line operation as well as in conjunction with frequency converters.

These motors are intended for use in industrial plants. They comply with the harmonized standards of the series IEC/EN 60034

Low-voltage motors are components designed for installation in machines in accordance with the current Machinery Directive. They must not be commissioned until it has been verified that the end product complies with this directive (refer to EN 60204-1).

The instructions are valid for 2EL, 3EL type electric motors.

### Environmental requirements

All of the ELK motors have a sound pressure level not exceeding 70 dB (A) at 50 Hz when operated at the rated output rated voltage

The motors are designed for the following conditions unless otherwise stated on the rating plate.

- Normal ambient temperature limits are -20°C to +40°C.
- Maximum altitude 1000 m above sea level.
- Tolerance for supply voltage is  $\pm 5\%$  in Zone A and  $\pm 10\%$  in Zone B. Tolerance for frequency is  $\pm 2\%$  for Zone A and  $+3\%$ ,  $-5\%$  for Zone B according to EN / IEC 60034-1.

These motors have not been designed for hazardous area applications.

### General safety rules:



Please read operating manual of motor for correct storage, installation, and operation.  
Mechanical and electrical installation and maintenance shall be done by qualified technicians!

For your personal safety and to prevent material damage when working on the motor, always observe the safety instructions and the following safety rules, according to EN 50110-1 ("Working in a voltage-free state).

- Disconnect the system. Disconnect the auxiliary circuits, for example anti-condensation heating
- Prevent reconnection.
- Make sure that the equipment is at zero voltage
- Ground and short-circuit the terminals
- Cover or isolate nearby components that are still live.

To energize the system, apply the measures in reverse order.

### WARNING

Electric motors contain live parts. Fatal or severe injuries and substantial material damage can occur if the required covers are removed or if the motors are not handled, operated, or maintained properly.

Electric motors contain dangerous rotating parts. Fatal or severe injuries and substantial material damage can occur if the required covers are removed or if the motors are not handled, operated, or maintained properly.

Electric motors have hot surfaces. Fatal or severe injuries and substantial material damage can occur if the required covers are removed or if the motors are not handled, operated, or maintained properly.

## General Definition and technical Properties of the motors:

All of our standard products are designed, manufactured, and tested according to the IEC and EN standards given below:

IEC 60034-1	Rating and performance
IEC 60034-2-1	Methods for determining losses and efficiency
IEC 60034-5	Classification of degrees of protection
IEC 60034-6	Methods of cooling
IEC 60034-7	Symbols of construction and mounting arrangements
IEC 60034-8	Terminal markings and direction of rotation
IEC 60034-9	Noise limits
IEC 60034-11	Built-in thermal protection
IEC 60034-14	Vibration limits
IEC 60034-18-1	Functional evaluation of insulation system
IEC 60034-30	Efficiency classes (IE-code)
IEC 60038	Standard voltages
EN 50347	Dimensions and output for electrical machines
EN 60204-1: 1993	(Safety of machinery - Electrical equipment of machines Part 1: General requirements)

Nameplate description;

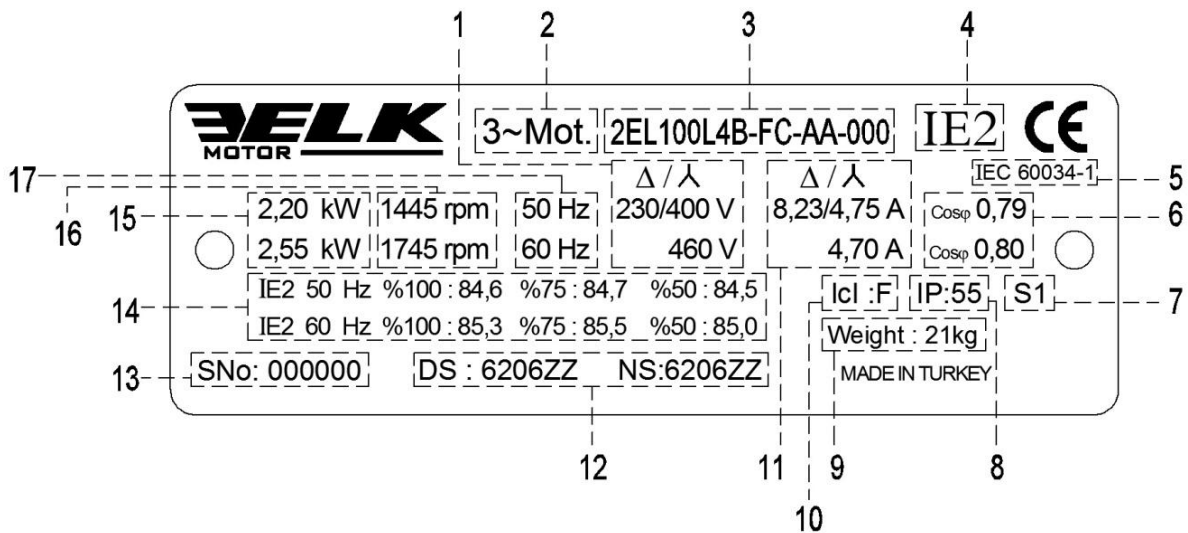

1.	Rated Voltage	9.	Motor Weight
2.	Motor Type: 3 Phase Asynchronous motor	10.	Insulation Class
3.	Motor Code	11.	Rated Current
4.	Efficiency Class	12.	Bearing Type
5.	Manufacture Standard	13.	Production Year/ Serial Number
6.	Power Factor	14.	Efficiency
7.	Duty Cycle	15.	Output Power
8.	Ingress Protection Class	16.	Speed
		17.	Frequency



The nameplate shows the identification, and the most important technical data. The name plate also defines the limits of proper usage, and manufacturing year of the motors. The first two digits in the serial number, shows the manufacturing year. For example 15XXXXXXX shows that the product is manufactured in 2015

**Product type codes**

**2 EL 132 M 4 C - FC - 00 - 000**

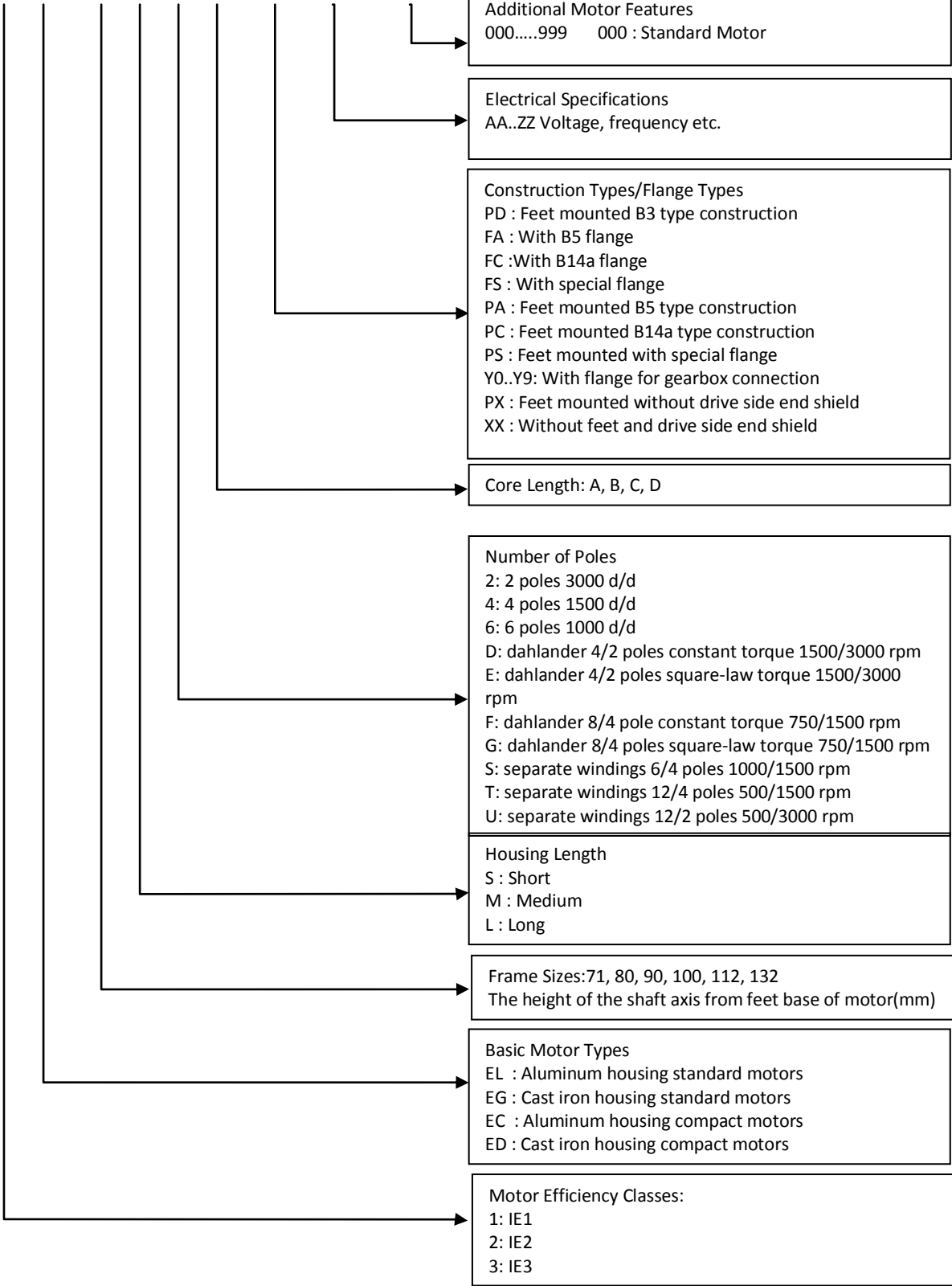



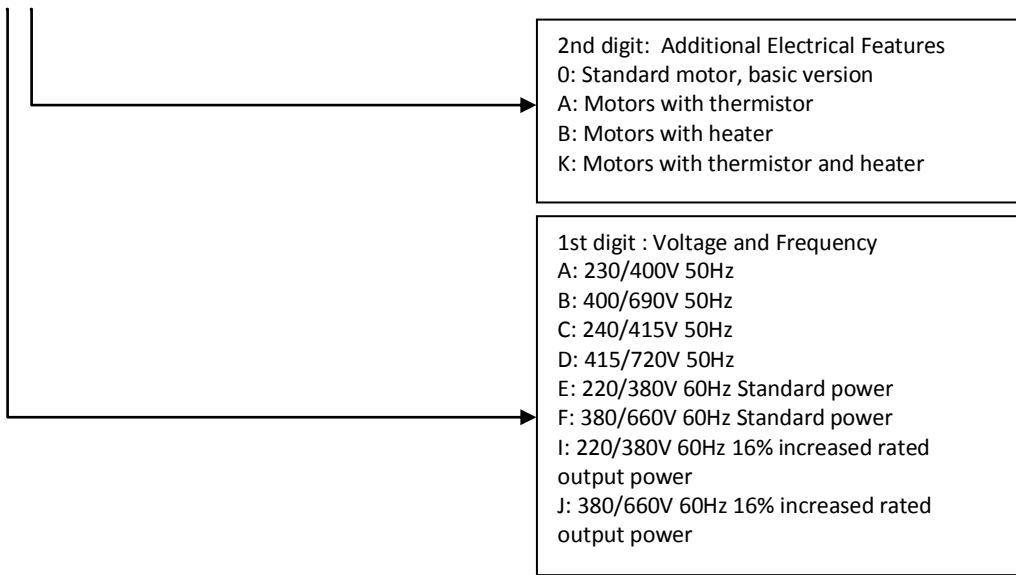

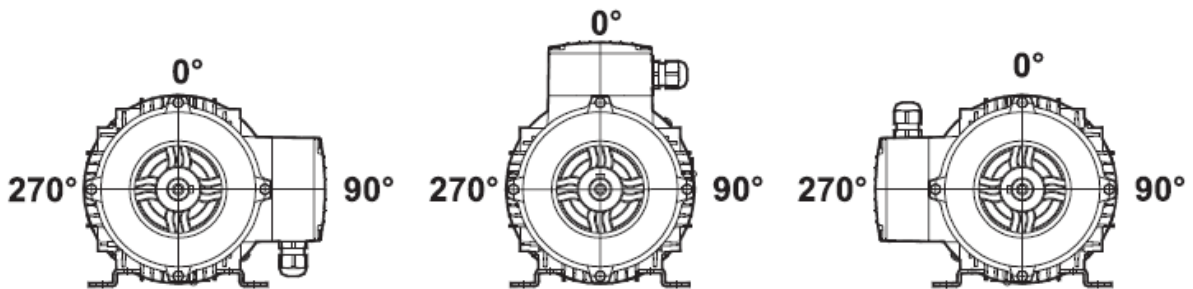

00

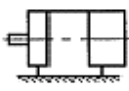
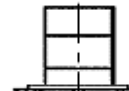
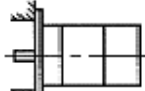

ELK Motors provides flexibility for different mounting types through their detachable feet which can be mounted on three sides. This feature allows terminal box assembly on the desired side. Standard motor terminal box position is on Top

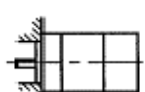
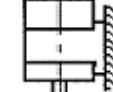
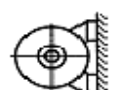
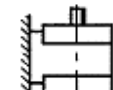

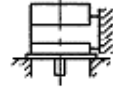
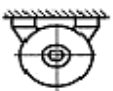
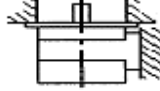
ELK electric motors are manufactured according to International Mounting Standard IEC 60034-7.

International Mounting Code via IEC 60034-7					
Horizontal Mounting Alpha Numeric Marking			Vertical Mounting Alpha Numeric Marking		
	I	II		I	II
	IM B3	IM 1001		IM V1	IM 3011
	IM B5	IM 3001		IMV3	IM3031
	IM B14	IM 3601		IM V5	IM 1011
	IM B7	IM 1061		IMV6	IM1031
	IM B6	IM 1051		IM V15	IM 2011
	IM B8	IM 1071		IM V35	IM 2031
	IM B34	IM 2101			
	IM B35	IM2001			



©ELK MOTOR

## 2. LIFTING AND STORAGE



Please check delivered product if any damages can exist in transportation process.

Motors above 25 kg weight have lifting lugs or eye bolts. The actual weight of motors is shown on the nameplate.

- Only the main lifting lugs or eyebolts of the motor should be used for lifting the motor.
- Use all the lifting eyes on the motors.
- Don't use damaged lifting lug.

Shocks, falls, and humidity should be avoided during transportation

During storage, following conditions must be satisfied;

- The storage rooms must provide protection against extreme weather conditions. They must be dry, free from dust, frost, and vibration, and well ventilated.
- Temperature shall be between -20°C and 40°C.
- Motor shaft shall be rotated by hand at least once per year.
- Protect motors from direct effect of sun and from gases that have corrosion impact on motors.
- Unprotected machined surfaces (shaft-ends and flanges) should be treated against corrosion.
- Open any condensation drain holes to drain the condensation (<6 months).
- If an anti-condensation heater is provided, switch it on during the machine stoppages.

## 3. COMMISSIONING

Immediately upon receipt, check the motor for external damage (e.g. shaft-ends and flanges and painted surfaces) and if found, inform the forwarding agent without delay.

Check all nameplate data, especially voltage and winding connection (star or delta) to ensure that the motor protection and connection will be properly done.

### Checking the insulation resistance

Motor winding insulation resistance shall be measured prior to starting the motor, if the winding is too damp.



WARNING

- Only appropriately trained personnel may carry out this work.
- Before starting commissioning, install all covers that are designed to prevent active or rotating parts from being touched
- If any power cables are connected, check to make sure line supply voltage cannot be connected.
- Once you have measured the insulation resistance, discharge the winding by connecting to the ground potential.
- Measurement of insulation resistance should be performed while the motor is not in operation.

If the measurements are performed at winding temperatures not equal to 25 °C, convert the measured value to the reference temperature of 25 °C in order to be able to compare the values with the table below.

- The insulation resistance halves every time the temperature rises by 10 K.
- The resistance doubles every time the temperature falls by 10 K.

Insulation resistance, corrected to 25°C, must be higher than the reference value given below.

If the reference resistance value is not attained, the winding is too damp and must be oven dried. The oven temperature should be 90-100 °C for 12 hours.

Insulation resistance of the stator winding at 25 °C	
Measuring circuit voltage	500 V
Minimum insulation resistance for new, cleaned or repaired windings	100 MΩ

## 4. MECHANIC INSTALLATION

### Safety considerations

- The machine is intended for installation and use by qualified personnel, familiar with health and safety requirements and national legislation.
- Safety equipment necessary for the prevention of accidents at the installation and operating site must be provided in accordance with local regulations.
- The temperature of the outer casing of the motor may be too hot to touch during normal operation and especially after shut-down.
- Be aware of rotating parts of the motor.
- Do not open terminal boxes while energized.

Before start-up, please check that

- Condensation drain holes are always located at the lowest point of the motor!
- Connect the motor corresponding to the specified direction of rotation.
- Ensure that all seals and sealing surfaces are undamaged and clean.

When aligning and fastening the motor, please bear the following in mind:

- The motor shall be mounted on a base, which is rigid enough to prevent distortion and vibration.
- Feet and flanges must be fastened securely.
- Avoid using rigid coupling measures.
- The motors must be carefully aligned. Incorrect alignment can lead to bearing failure, vibration, even shaft fracture.
- Coupling halves and pulleys must be fitted on the shaft by using suitable equipment and tools which do not damage the bearings and seals. Never fit a coupling half or pulley by hammering or by removing it using a lever pressed against the body of the motor
- Excessive belt tension will damage bearings and can cause shaft damage.
- If a belt drive is used, make sure that the driving and the driven pulleys are correctly aligned.
- The motor should be mounted in such a way that the cooling air should flow to and away from the motor without obstruction.
- For Technical details about the motor dimensions see the catalogue.
- Do not exceed permissible loading values for bearings as stated in the product catalogues.

As standard, balancing of the motor has been carried out using half key

Coupling halves or pulleys must be balanced after machining the keyways. Balancing must be done in accordance with the balancing method specified for the motor.

## 5. ELECTRICAL INSTALLATION AND OPERATION CONDITIONS



Before installation, check motor specifications from nameplate if they fit the requirements of the load and specification of voltage and frequency.



Measure the insulation resistance between windings and housing. Please check detailed information in the Checking the insulation resistance section.



## WARNING

Note the following safety information before connecting-up the motor:

- Only qualified and trained personnel should carry out work on the motor while it is stationary.
- Disconnect the motor from the power supply and take measures to prevent it being reconnected. This also applies to auxiliary circuits.
- Check that the motor really is in a no-voltage condition.
- Establish a safe protective conductor connection before starting any work.
- It must be ensured that there are no foreign bodies, dirt, or moisture in the terminal box.
- Keep the inside of the terminal box clean and free from trimmed-off ends of wire.
- Close any additional open cable entries with O-rings or suitable flat gaskets, the terminal box itself must be sealed so that it is dust and water tight using the original seal.
- When performing a test run, secure the feather keys without output elements.
- Earthing must be carried out according to local regulations before the machine is connected to the supply voltage.

## Terminals and direction of rotation

The standard motors are suitable for clockwise and counter-clockwise rotation.

When the power cables L1, L2, L3 are connected to U1, V1, W1 respectively, the motor shaft turns in clockwise direction (looking at the shaft from drive side). If two of the power cables are interchanged then the resulting direction of rotation is counter-clockwise.

Select the connecting cables in accordance with the rated current, ambient temperature, cable gland and routing method etc. according to IEC/EN 60204-1.

Please observe the tightening torques for cable glands, terminal screws, and other screws.

In addition to the main winding and earthing terminals, the terminal box can also contain connections for thermistors, heating elements or other auxiliary devices.

The terminal box on standard single speed motors normally contains six winding terminals and at least one earth terminal. This enables the use of DOL or Y/D starting.

The motors shall be connected in star or delta according to rated voltage given in their nameplate and the network voltage that they will be connected. For phase to phase 400 V supply, the motors with 230/400V nameplate values shall be connected in star (Y) and the motors with 400/690V nameplate values shall be connected in delta ( $\Delta$ ).

Terminal connection for single speed motor;

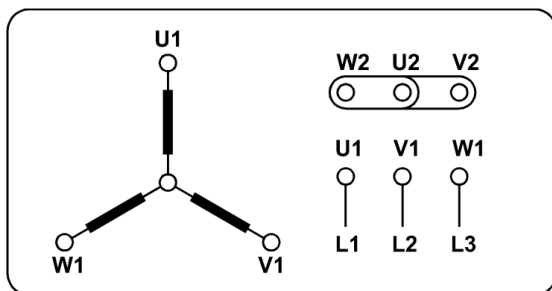

Star Connection

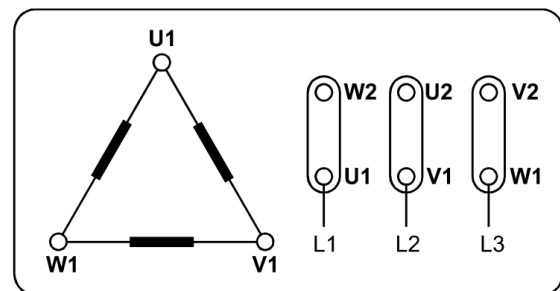

Delta Connection

Terminal connection of double speed motor;

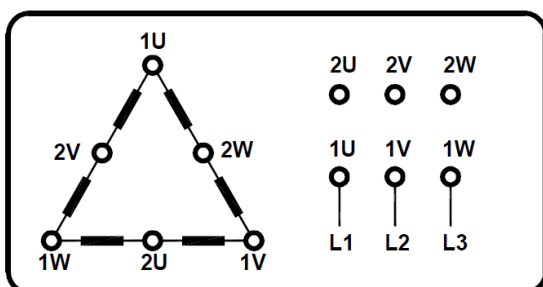

Low Speed

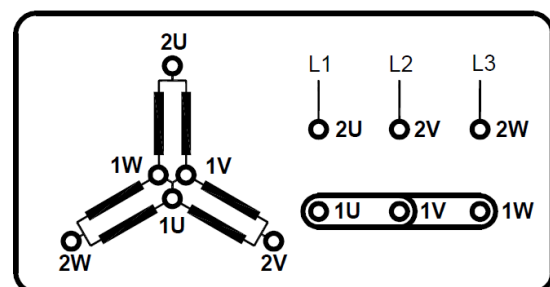

High Speed

Terminal connection of Dahlander motor;

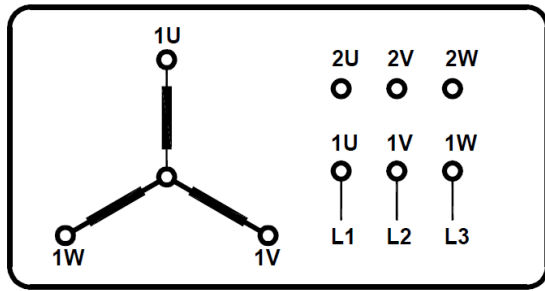

Low Speed

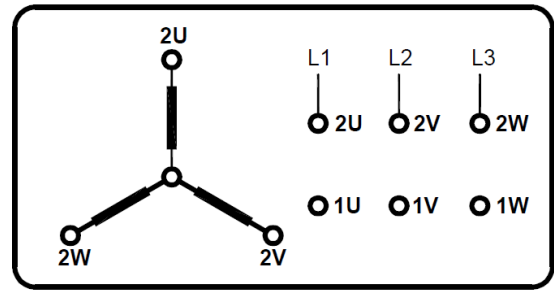

High Speed

Tightening torques for electrical connections on the terminal board							
ThreadØ		M4	M5	M6	M8	M10	M12
Nm	min	0,8	1,8	2,7	5,5	9	14
	Max.	1,2	2,5	4	8	13	20

The cable glands according to the frame size.		
Frame Size	71 - 80 - 90	100 - 112-132
Cable Glands	M20 +M16	M25 + M25

Cable Gland Tightening Torque ±10% Nm	
M 16	2
M20	4
M25	4

Our standard motors have insulation Class F while the temperature rise is Class B. This means the motors will have a longer service life and work under hard conditions.

Motors are designed to operate at altitudes up to 1000 m and ambient temperature up to 40°C according to IEC 60034-1. Rated output will change at the % ratings given below for different altitudes and ambient temperatures.

Rated power changes according to the altitude;							
ALTITUDE	Up to 1000m	Up to 1500 m	Up to 2000m	Up to 2500m	Up to 3000m	Up to 3500m	Up to 4000m
% Power Ratio	100	98	95	91	87	83	78

Rated power changes according to ambient temperature;							
AMBIENT TEMPERATURE	<30 °C	35 °C	40 °C	45 °C	50 °C	55 °C	60 °C
% Power Ratio	105	102	100	97	93	87	82

Our standard motors that have been manufactured for 50 Hz power supply, can also be used at 60 Hz network. The ratios given below indicate changes in the given rated values.

50Hz Rated Voltage	60Hz Supply Voltage	Rated speed	Rated Power	Rated Torque	Rated Current	Starting Torque	Break Down Torque	Starting Current
230V	220V	1.193	1	0.84	0.97	0.77	0.8	0.8
400V	380V	1.193	1	0.84	0.97	0.77	0.8	0.8
400V	440V	1.20	1.16	0.97	0.98	0.87	0.9	0.9

When operating at speeds above rated speed, for example when used with frequency converters, for adjustable speed control, noise and vibration levels will be increased and bearing lifetime will be decreased. The user may require fine balance for better operation above the rated speed. Attention should be paid to the re-greasing intervals and the grease service life.

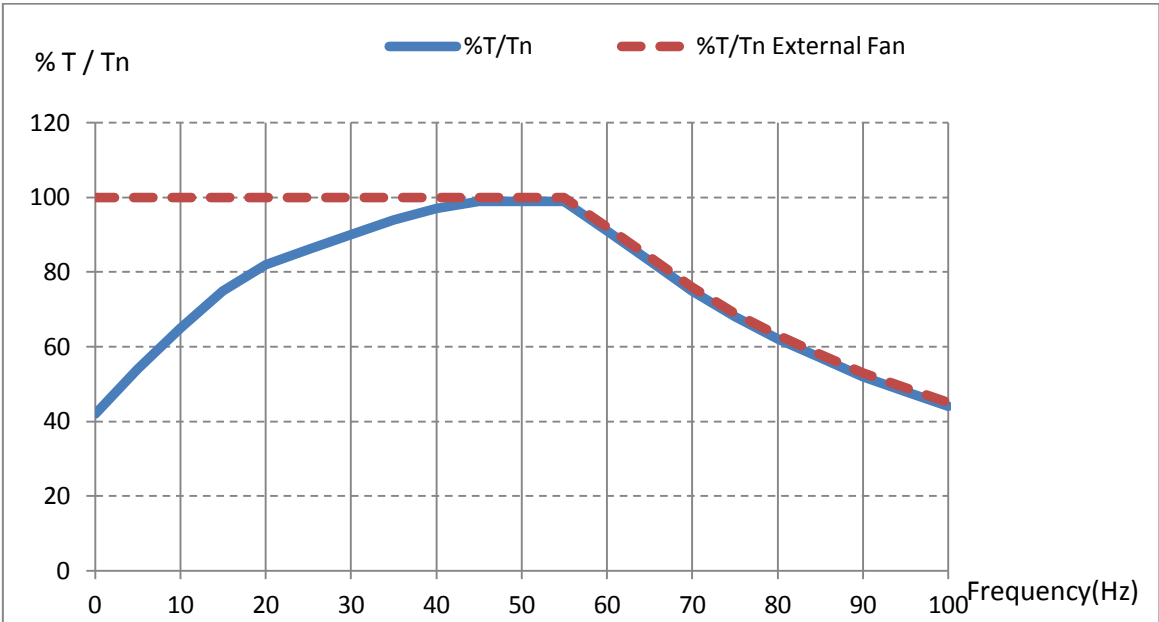

Standard ELK motors are suitable for electronic speed control operations. The frequency range that the motor can be driven with their fan is shown with blue (continuous) line in the above graph. If the motor will be driven in a wider range, then an external fan is necessary. By using an external fan the motors can be driven in the range defined by red (dashed) line.

Do not exceed the speeds given in the table because high speeds increases the level of vibration and noise, and the bearing lifetime may be reduced.

Maximum safe operating speed (rpm) of three-phase single-speed cage induction motors			
Frame Size	2 Pole	4 Pole	6 Pole
<100	5400	3600	2400
112	5200	3600	2400
132	4500	3000	2400

Both IE2 and IE3 efficiency class motors are suitable for operation on frequency converters. Whenever the peak voltage and the rise time of the pulses at motor terminals are within the limit of the curve given below, there will be no significant decrease in motor lifetime.

The maximum allowed phase to phase voltage peaks ( $\hat{U}_{LL}$ ) at the motor terminals, as a function of the rise time ( $t_r$ ) of the pulse, is shown in the figure below.

Suitable filters must be incorporated at the converter output to not decrease insulation lifetime, whenever the peak voltages are not within the limit of the curve.

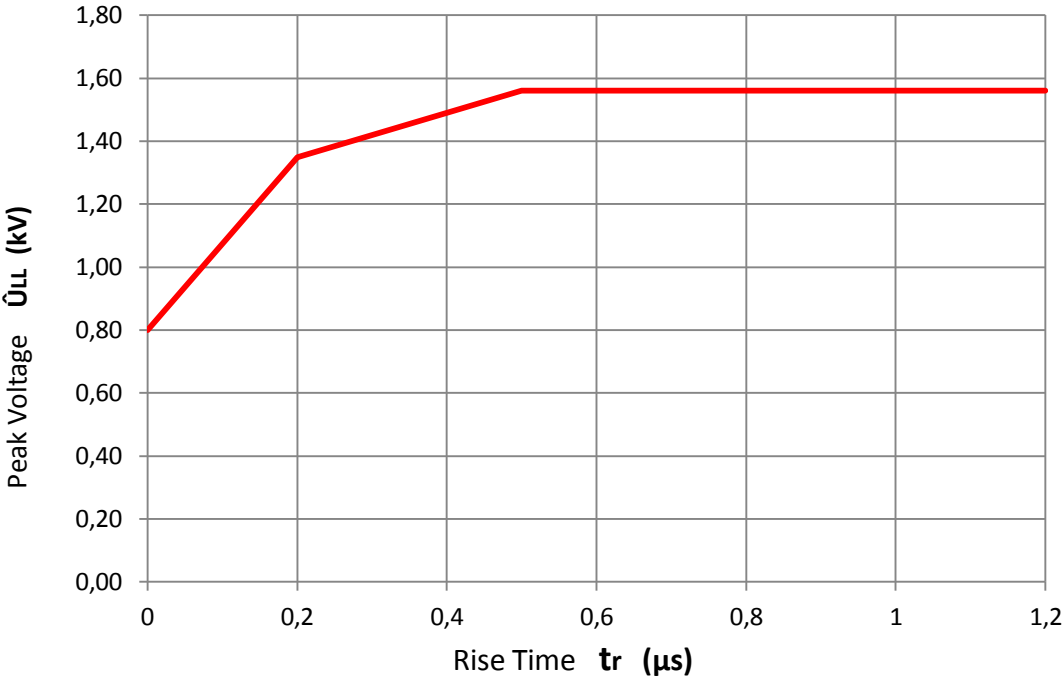

Limit curves of admissible motor terminal peak voltage for motors up to and including 500 V a.c. rated voltage

## 6. TROUBLESHOOTING

Motor service and any troubleshooting must be handled by qualified persons who have proper tools and equipment. Before rectifying any faults, please read the information in the section titled Safety information

Defect	Cause	Solution
Motor does not start	Blown fuses	Replace the fuses with correct one with rated value
	Incorrect line connections	Check the connections
	Motor overloaded	Decrease the load
	Mechanical damage	Check whether the motor and drive rotate freely
	One of the phases may be open	Check the phases on the line
Motor stalls	One of the phases may be open.	Check if there is a broken phase on the lines
	Improper motor selection.	Change the type or size. Contact the device's supplier or designer.
	Overload.	Decrease the load
	Low voltage.	Check whether the voltage stated on the rating plate is maintained. Check the connection.
	Open power supply or control circuit.	Blown fuses, check the load relay, stator and control buttons.
Motor takes a long time to gain speed	Low voltage	Check the circuit capacity and power source
	Over loading	Decrease the load
	Rotor damaged	Replace the rotor
	Incorrect converter settings	Correct the settings
Motor runs and die down	Power failure	Check for a loose connection in the power supply line, fuses and control.
Wrong rotation direction	Wrong sequence of phases	Reverse connections at terminals
Motor heats up excessively	Motor overloaded	Decrease the load
	Low voltage	Adjust motor to supply voltage
	Ambient temperature is too high	Observe the permitted temperature range, decrease the load if necessary or check the insulation class and use appropriate special motor
	Insufficient cooling	Provide air cooling supply, clean cooling air passages
	Bearing failure	Replace the bearings
	Unbalanced voltage	Check the circuit
	Short circuit in motor's winding	Rewind the motor
	One of the phases may be open	Check the phases on the line
	Broken ventilator or lack of ventilator	Check the ventilator
Noisy Operation	One of the phases may be open	Check the phases on the line
	Air gap not uniform	Check the bearing fits
	Fan rubbing end shield or fan cover	Check the fan mounting
	Broken ventilator	Replace the ventilator
	Incorrect coupling of the motor with the driven machine	Adjust the motor orientation and belt tension
	Broken rotor bar	Replace the rotor

## Faults during operation

Deviations from conditions during normal operation, such as an increase in power consumption, temperatures or vibrations, unusual noises or odors, tripping of monitoring devices, etc., indicate that the motor is not functioning properly. This can cause faults which can result in eventual or immediate death, severe injury, or material damage.

- Immediately inform the maintenance personnel.
- If you are in doubt, immediately switch off the motor, being sure to observe the system-specific safety conditions.

## 7. INSPECTION

### Safety instructions

- Before starting work on the motors, make sure that the plant or system has been disconnected in a manner that is compliant with the appropriate specifications and regulations.
- In addition to the main currents, make sure that supplementary and auxiliary circuits, particularly in heating devices, are also disconnected.
- A motor with frequency converter supply may energize even if the motor is at standstill.
- Certain parts of the motor may reach temperatures above 50 °C. Physical contact with the motor could result in burn injuries! Check the temperature of parts before touching them.

### General inspection

Inspect the motor at regular intervals, at least once a year. The frequency of checks depends on, for example, the humidity level of the ambient air and on the local weather conditions. This can initially be determined experimentally and must then be strictly adhered to.

Keep the motor clean and ensure free ventilation airflow. If the motor is used in a dusty environment, the ventilation system must be regularly checked and cleaned.

- ✓ Check the condition of shaft seals and replace if necessary.
- ✓ Check the condition of connections and mounting and assembly bolts.
- ✓ Check the bearing condition by listening for any unusual noise, vibration measurement, bearing temperature, inspection of spent grease.
- ✓ Check if the electrical parameters are maintained.
- ✓ Check if the winding insulation resistances are sufficiently high.
- ✓ Check if the cables and insulating parts and components are in a good condition and are not discolored.

Immediately correct any impermissible deviations that are determined in the inspection.

If the paint is damaged, it must be repaired in order to protect the unit against corrosion.

Pay special attention to bearings when their calculated rated life time is coming to an end.

When signs of wear are noticed, dismantle the motor, check the parts, and replace if necessary. When bearings are changed, replacement bearings must be of the same type as those originally fitted. The shaft seals have to be replaced with seals of the same quality and characteristics as the originals when changing bearings.

In the case of the IP 55 motor and when the motor has been delivered with a plug closed, it is advisable to periodically open the drain plugs in order to ensure that the way out for condensation is not blocked and allows condensation to escape from the motor. This operation must be done when the motor is at a standstill and has been made safe to work on.

The calculated life of the bearings of 2Z, 2RS according to ISO 281 is at least 20,000 hours with utilization of the permissible radial/axial forces. However, the achievable useful life of the bearings can be significantly longer in the case of lower forces.

Coolant temperature	Principle of operation	Bearing replacement intervals
40° C	Horizontal coupling operation	40 000 h
40° C	With axial and radial forces	20 000 h

## **8- MAINTENANCE and REPAIR**

### **Cleaning**

Regularly clean the cooling air passages through which the ambient air flows, e.g. using dry compressed air.

Particularly when carrying out cleaning using compressed air, make sure you use suitable safety wear

If there are condensate drain holes present, these must be opened at regular intervals, depending on climatic conditions. To maintain the degree of protection, any condensation drain holes need to be closed.

### **Instructions for repair**

Only appropriately qualified persons should be deployed to commission and operate equipment. Qualified persons, as far as the safety instructions specified in this manual are concerned, are those who have the necessary authorization to commission, ground and identify equipment, systems and circuits in accordance with the relevant safety standards.

Before you begin working on the three-phase motor, in particular before you open the covers of active parts, make sure that the three-phase motor or system is properly isolated from the supply.

### **Replacing bearings**

Special care should be taken with the bearings. These must be removed using pullers and fitted by heating or using special tools for the purpose.

Do not reuse bearings that have been removed.

### **Rewinding**

Rewinding should always be carried out by qualified repair shops

### **Assembly**

If possible, assemble the motor on an alignment plate.

Avoid damaging the windings protruding out of the stator enclosure when fitting the end Shield

Take care not to damage the cable jacket. Tightening torques must be adapted to suit the type of cable jacket material in use.

Shaft sealing should be assembled to the right position without any damage

- Check the terminal box seals and if required, replace.
- Do not forget the foam cover in the cable entry (seal all holes completely and prevent cables from touching any sharp edges).
- Repair any damage to the paint (also on screws/bolts).
- Check the tightening torques of all screws, as well as those of screws which have not been unscrewed.

## 9- SPARE PARTS

2EL and 3EL series motors consist of the following main parts;

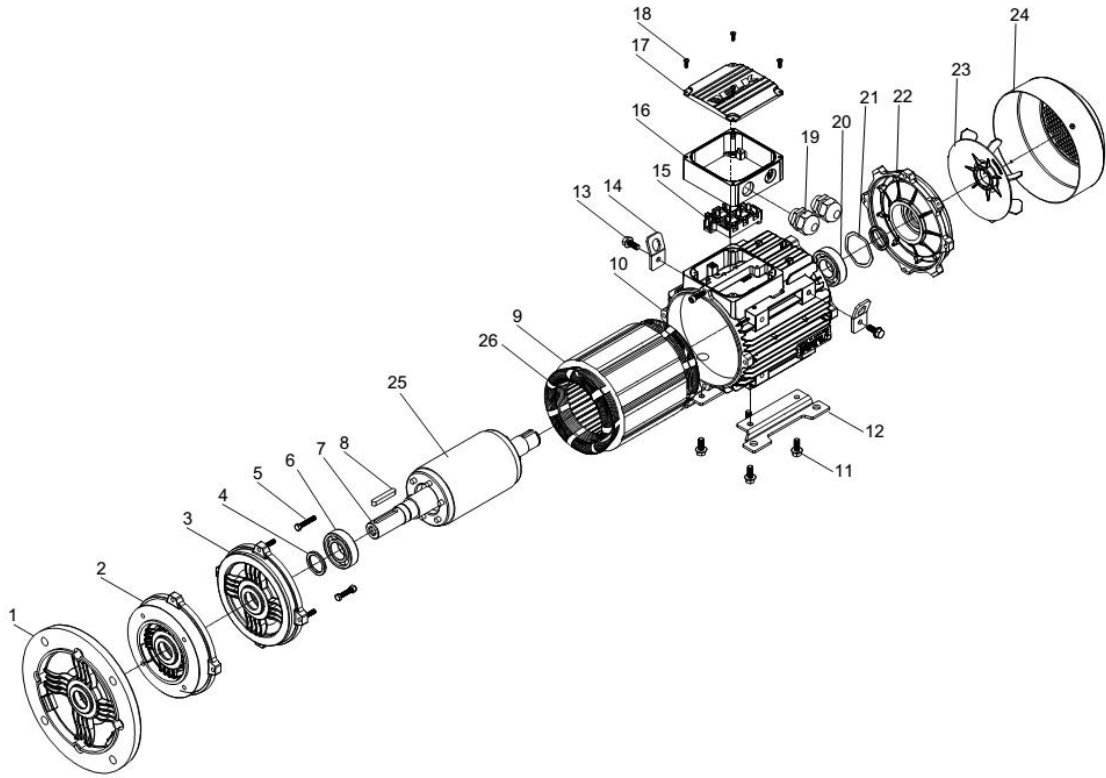

- |                          |                               |
|--------------------------|-------------------------------|
| 1. Flange B14            | 14. Lifting lug               |
| 2. Flange B5             | 15. Terminal                  |
| 3. Drive side end shield | 16. Terminal box              |
| 4. Shaft Sealing ring    | 17. Terminal box cover        |
| 5. Screw                 | 18. Bolt                      |
| 6. Bearing               | 19. Cable gland               |
| 7. Shaft                 | 20. Bearing                   |
| 8. Key                   | 21. Spring washer             |
| 9. Stator Core           | 22. Non drive side end shield |
| 10. Housing              | 23. Fan                       |
| 11. Screw                | 24. Fan cover                 |
| 12. Mounting foot        | 25. Squirrel cage rotor       |
| 13. Screw                |                               |

When ordering spare parts, the motor serial number, full type designation, and product code, as stated on the nameplate, must be specified.

For field service, spare parts, and additional information please contact local sales office, if local sales office is not available please contact our factory, that name and address is given below

<b>MES Elektromekanik Dokum San. ve Tic. A.S.</b>	G.O. Paşa Mah. 1.Cad No : 125 2. Org. San. Bolgesi 59500 Cerkezkoy / Tekirdag / Turkey Tel : +90 282 726 92 94 Fax : +90 282 726 90 42 Mailto : <a href="mailto:info@mesdokum.com.tr">info@mesdokum.com.tr</a>
---	--



## **10- DISPOSAL**

Environmentally friendly design, technical safety, and health protection are always main target for us even at the product development stage.

Recommendations for the environmentally friendly disposal of the motor and its components are given in the following section. Be sure to comply with local disposal regulations.

Dismantle the motor using the general procedures commonly used in mechanical engineering.

### **Disposal of components**

The motors mainly consist of steel, copper, and aluminum. Metals are generally considered to be unlimitedly recyclable.

Sort the components and process materials for recycling according to what they are:

- Iron and steel
- Aluminum
- Winding (enameled copper wire); the winding insulation is incinerated during copper recycling.
- Insulating materials
- cables and wires
- Oil
- Grease
- Cleaning substances and solvents
- Paint residues
- Anti-corrosion agent

Dispose of the separated components according to local regulations or via a specialist disposal company

### **Packaging material**

- if necessary, contact a suitable specialist disposal company.
- Wooden packaging for sea transport consists of impregnated wood. Observe the local regulations.